

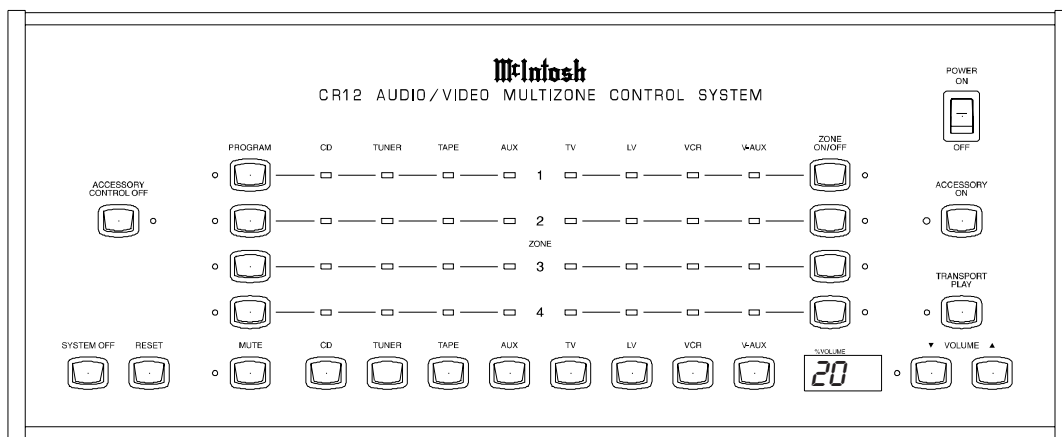

## CR12 Audio/Video Multizone Control System



CR12



## Thank You, Please Take A Moment, Customer Service and Table of Contents

### Thank You

For your decision to own this McIntosh CR12 Audio/Video Multizone Control System ranks you at the very top among discriminating music listeners. You now have “The Best.” The McIntosh dedication to “Quality,” is assurance that you will receive many years of musical enjoyment from this unit.

Please take a short time to read the information in this manual. We want you to be as familiar as possible with all the features and functions of your new McIntosh CR12. This will ensure that you receive all the performance benefits this equipment can offer you, and that it will become a highly valued part of your home entertainment system.

### Please Take A Moment

The serial number, purchase date and McIntosh dealer name are important to you for possible insurance claim or future service. The serial number is located on the rear panel of the equipment. The spaces below have been provided for you to record that information:

#### Serial Number:

#### Purchase Date:

#### Dealer Name:

### Customer Service

If at any time you have questions about your CR12 Audio/Video Multizone Control System, please contact:

McIntosh Laboratory, Inc.  
2 Chambers Street  
Binghamton, New York 13903  
Phone: 607-723-3512  
FAX: 607-724-0549

### Table of Contents

Thank You .....	2
Please Take a Moment .....	2
Customer Service .....	2
Table of Contents .....	2
Safety Instructions .....	3
Introduction .....	4
Performance Features .....	4
Pre-Installation .....	5
Installation .....	6
Rear Panel Controls, Connections and Switches .....	7
How to Connect the CR12 with a C39/MX130 .....	8
How to Connect Additional CR12's .....	9
How to Connect the CR12 in a Stand Alone System .....	10
CR12 Front Panel Displays, Push-Buttons, and Switch .....	11
How to Operate from the Front and Rear .....	12
How to Operate in Remote Zones .....	13
How to Program the CR12 .....	14
HR-033 Push-Buttons .....	16
How to Operate by Remote Control .....	17
Specifications .....	18
Packing Instructions .....	19

#### NOTES:

1. Up to four sensors or keypads can be wired in parallel for a single zone.
2. For additional information on Video and Audio connections, refer to the owner's manual(s) for the component(s).

## IMPORTANT SAFETY INSTRUCTIONS!

PLEASE READ THEM BEFORE OPERATING THIS EQUIPMENT.



**WARNING SHOCK HAZARD - DO NOT OPEN.**



**AVIS RISQUE DE CHOC - NE PAS OUVRIR.**



**NO USER-SERVICEABLE PARTS INSIDE. REFER SERVICING TO QUALIFIED PERSONNEL**



### General:

1. Read all the safety and operating instructions, contained in this owner's manual, before operating this equipment.
2. Retain this owner's manual for future reference about safety and operating instructions.
3. Adhere to all warnings and operating instructions.
4. Follow all operating and use instructions.
5. **Warning: To reduce risk of fire or electrical shock, do not expose this equipment to rain or moisture. This unit is capable of producing high sound pressure levels. Continued exposure to high sound pressure levels can cause permanent hearing impairment or loss. User caution is advised and ear protection is recommended when playing at high volumes.**
6. **Caution: to prevent electrical shock do not use this (polarized) plug with an extension cord, receptacle or other outlet unless the blades can be fully inserted to prevent blade exposure.**  
**Attention: pour prevenir les chocs electriques pas utiliser cette fiche polarisee avec un prolongateur, une prise de courant ou un autre sortie de courant, sauf si les lames peuvent etre inserees afond ans en laisser aucune partie a decouvert.**
7. For added protection for this product during a lightning storm, or when it is left unattended and unused for long periods of time, unplug it from the wall outlet and disconnect the antenna or cable system. This will prevent damage to the product due to lightning or power line surges.

8. Do not use attachments not recommended in this owner's manual as they may cause hazards.

### Installation:

9. Locate the equipment for proper ventilation. For example, the equipment should not be placed on a bed, sofa, rug, or similar surface that may block ventilation openings; or, placed in a built-in installation, such as a bookcase or cabinet, that may impede the flow of air through the ventilation openings.
10. Locate the equipment away from heat sources such as radiators, heat registers, stoves, or other appliance (including amplifiers) that produce heat.
11. Mount the equipment in a wall or cabinet only as described in this owner's manual
12. Do not use this equipment near water; for example, near a bathtub, washbowl, kitchen sink, laundry tub, in a wet basement or near a swimming pool, etc.
13. Do not place this product on an unstable cart, stand, tripod, bracket, or table. The equipment may fall, causing serious injury to a person, and serious damage to the product.

### Connection:

14. Connect this equipment only to the type of AC power source as marked on the unit.
15. Route AC power cords so that they are not likely to be walked on or pinched by items placed upon or against them, paying particular attention to cords at plugs, convenience receptacles, and the point where they exit from the instrument.
16. Do not defeat the inherent design features of the polarized plug. Non-polarized line cord adapters will defeat the safety provided by the polarized AC plug. If the plug should fail to fit, contact your electrician to replace your obsolete outlet. Do not defeat the safety purpose of the grounding-type plug.
17. Do not overload wall outlets, extension cords or integral convenience receptacles as this can result in a risk of fire or electric shock.

### Care of Equipment:

18. Clean the instrument by dusting with a dry cloth. Unplug this equipment from the wall outlet and clean the panel with a cloth moistened with a window cleaner. Do not use liquid cleaners or aerosol cleaners.
19. Do not permit objects of any kind to be pushed and/or fall into the equipment through enclosure openings.



Never spill liquids into the equipment through enclosure openings.

20. Unplug the power cord from the AC power outlet when left unused for a long period of time.

#### **Repair of Equipment:**

21. Unplug this equipment from the wall outlet and refer servicing to a qualified service personnel under the following conditions:
  - A. The AC power cord or the plug has been damaged,
  - B. Objects have fallen, or liquid has been spilled into the equipment,
  - C. The equipment has been exposed to rain or water,
  - D. The equipment does not operate normally by following the operating instructions contained within this owner's manual. Adjust only those controls that are covered by the operating instructions, as an improper adjustment of other controls may result in damage and will often require extensive work by a qualified technician to restore the product to its normal operation,
  - E. The equipment has been dropped or damaged in any way,
  - F. The equipment exhibits a distinct change in performance - this indicates a need for service.
22. Do not attempt to service beyond that described in the operating instructions. All other service should be referred to qualified service personnel.
23. When replacement parts are required, be sure the service technician has used replacement parts specified by McIntosh or have the same characteristics as the original part. Unauthorized substitutions may result in fire, electric shock, or other hazards.
24. Upon completion of any service or repairs to this product, ask the service technician to perform safety checks to determine that the product is in proper operating condition.

#### **Introduction**

Now you can take advantage of traditional McIntosh standards of excellence in the CR12 advanced design Audio/Video Multizone Control System. You only need to push a button on a remote controller or a keypad to enjoy music and video programs throughout your home with McIntosh quality and reliability. The heart of the CR12 consists of four, independent, remotely controlled stereo preamplifiers.

#### **Performance Features**

- **Four Independent Preamplifiers**

The CR12 consists of four independent stereo Audio/Video preamplifiers that can be remotely controlled from four separate zones.

- **Separate Programming**

Each of the four zones can be programmed from the CR12 front panel for selection of signal source and wakeup volume level.

- **Eight Source Selection**

Select any of four stereo audio/video signal sources, and four stereo audio signal sources in each zone using a keypad or Remote Control.

- **Local Source Zone Selection**

An audio/video or audio signal source component can be dedicated to operate only in a specific zone.

- **Independent Zone Tone Adjustment**

Individual bass and treble controls for each zone allow tone shaping to optimize audio performance for different speakers and room acoustics.

- **Video Switching**

Matched and buffered video switching ensures perfect picture integrity from the latest high resolution video sources.

- **Front Panel Zone Display**

The front panel display shows the status of each zone.

- **Accepts all McIntosh Keypads**

Three different McIntosh keypad models can be used with the CR12.

- **Four Keypads and/or Sensors per Zone**

Each remote zone can accommodate up to four keypads or wall sensors to select and operate all the available signal source components.

## Connector Information

### Keypad Terminal Connector

To use a WK-3 or WK-4 keypad, connect the shield and four leads of a shielded 4 conductor cable to a keypad terminal connector, according to the numbers listed below. There is a similar numbered connector built-in to each keypad.

1. Supply Voltage Positive
2. Supply Voltage Ground
3. Cable Shield
4. Signal Data
5. Signal Data Ground

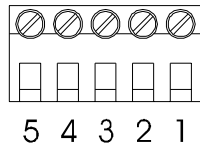

### Din Connector Pin Layouts for Balanced Outputs

1. Left Channel (-)
2. (Not used)
3. Right Channel(-)
4. Left Channel Ground
5. Right Channel Ground
6. Left Channel (+)
7. Right Channel (+)

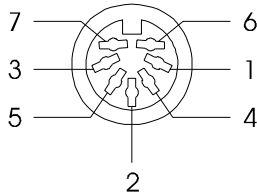

## Connecting Cables and Connectors

Connecting Cables and Connectors are available from the McIntosh Parts Department:

### Data and Power Control Cable Part No. 170-202

Six foot, shielded 2 conductor, with 1/8 inch stereo mini phone plugs on each end

### Control Center to CR12 Cable Part No. 170-203

Three foot, DB25, Shielded, straight through, 25 conductor male-to-male cable.

### CR12 to CR12 Cable Part No. 170-430

Six foot, DB37, shielded, straight through, 37 conductor male-to-male cable.

### Control Center to Multi Channel Power Amplifier Cable Part No. 170-631

Six foot, DB25, shielded, straight through, 25 conductor male-to-female cable.

### CR12 Keypad Terminal Plug Part No. 117-634

Five Pin connector for attaching the 4 conductor cable to the CR12 Keypad Socket.

## CR12 Front Panel Sensor Disabling

If the CR12 is interconnected with a McIntosh C39 or MX130 A/V Control Center, and both components are located together, the internal front panel IR sensor must be disabled. This avoids interference problems caused by sending IR commands simultaneously to the front panel sensors of BOTH units.

1. Remove the top cover of the CR12.
2. With the CR12 front facing you, locate a small slide switch on the large vertical circuit board near the top of the right side behind the front panel.
3. Move the switch to the Right.

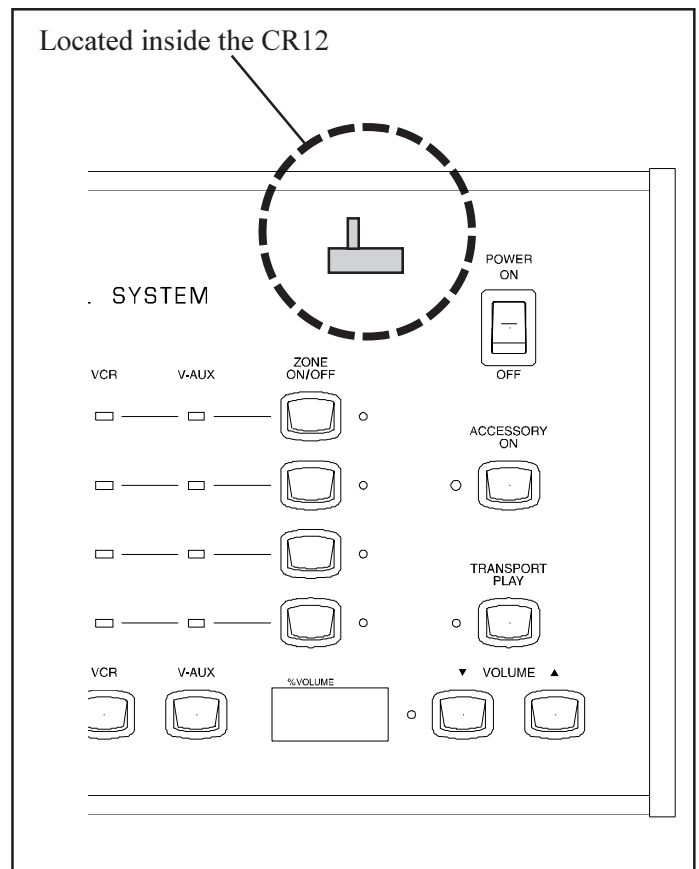



### Installation

The CR12 can be placed upright on a table or shelf, standing on its four feet. It also can be custom installed in a piece of furniture or cabinet of your choice. The required panel cutout, ventilation cutout and unit dimensions are shown.

Always provide adequate ventilation for your CR12. Cool operation ensures the longest possible operating life for any electronic instrument. Do not install the CR12 directly above a heat generating component such as a high powered amplifier. If all the components are installed in a single cabinet, a quiet running ventilation fan can be a defi-

nite asset in maintaining all the system components at the coolest possible operating temperature.

A custom cabinet installation should provide the following minimum spacing dimensions for cool operation. Allow at least 1-1/2 inches (3.8cm) above the unit so airflow is not obstructed. Allow 17-1/2 inches (44.5cm) depth behind the mounting panel, which includes clearance for connectors. Allow 1-1/8 inches (2.9cm) in front of the mounting panel for knob clearance. Be sure to cut out a ventilation hole in the mounting shelf according to the dimensions in the drawing.

Front View of a CR12 custom installed

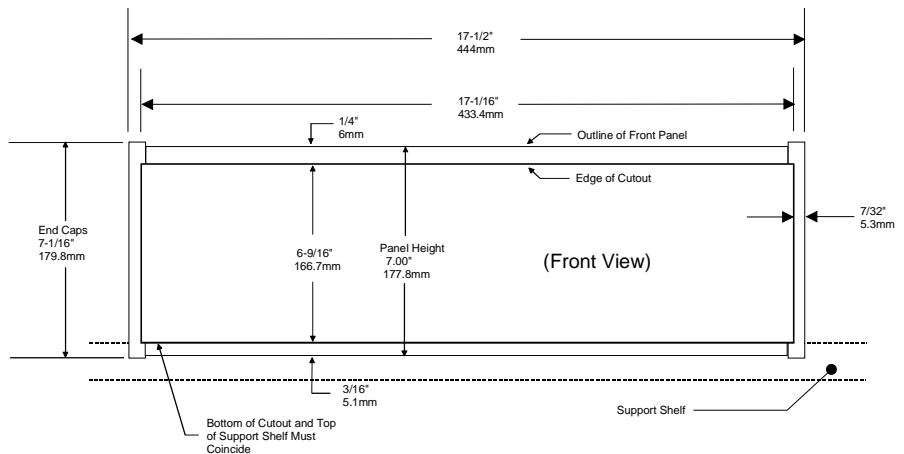

Side View of a CR12 custom installed

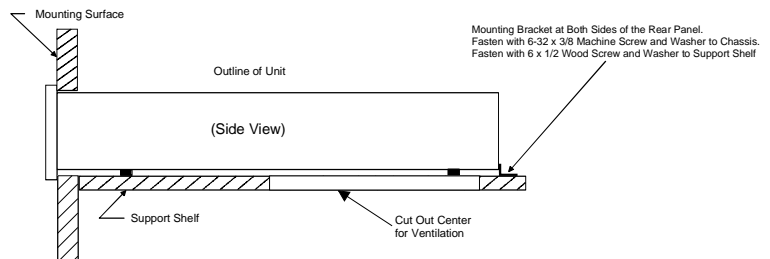

Bottom View of a CR12 custom installed

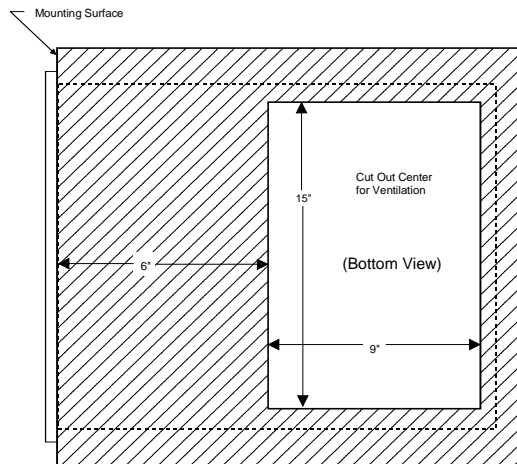



# CR12 Rear Panel Controls, Connections and Switches

## CR12 Rear Panel Controls, Connections and Switches

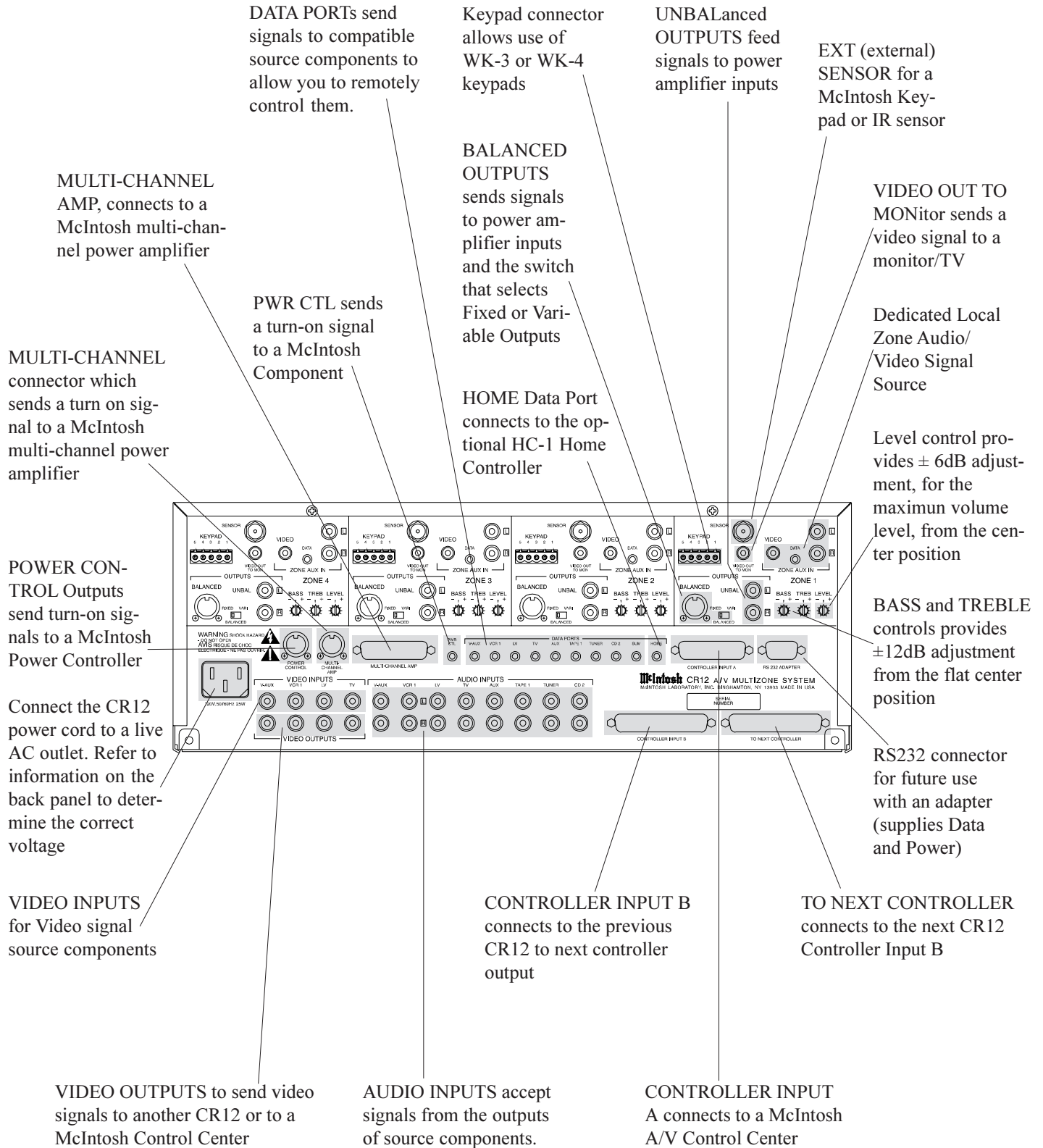



## How to Connect the CR12 with a C39/MX130

### How to Connect the CR12 with a C39/MX130

1. Connect the CR12 power cord to a live AC outlet.
2. Connect a McIntosh Power Controller to the CR12 using either the Din or Pwr Ctl connector and connect zone amplifier power cords to the appropriate outlets on the Power Controller.
3. Connect a McIntosh multi channel amplifier with a DB25 computer type cable from the CR12 Multi-Channel Amp connector to amplifier input connector.  
*Note: Both audio and zone power control pass through this cable. Discrete zone audio cables may also be used, either balanced or unbalanced. Refer to on Page 5 for the Din plug balanced terminal connections. Also connect a cable from the CR12 Din Multi-Channel Amp connector to the matching connector on the amplifier to provide zone power control.*
4. Connect a WK-3/WK-4 keypad, using 4 conductor shielded cable to a zone terminal connector or connect a WK-2 keypad or R649 wall sensor to a zone sensor connector with RG6 or RG59U coax cable.
5. Connect the video outputs of A/V source components to the CR12 video inputs and the CR12 video outputs to

6. the matching C39/MX130 video inputs.
6. Connect the Audio Outputs from A/V source components to both the CR12 and C39/MX130 inputs using a "Y" adapter if necessary.
7. For dedicated zone source components, connect their Audio, Video and Data outputs to the CR12 Zone Aux In connectors.  
*Note: The A/V source signals used in a dedicated zone replace the Aux signal source selection and are automatically switched when a plug is inserted into the Data port. If no data cable is used, insert 1/8 inch mini Stereo phone plug, (with a lead connected from the tip to the ring), to activate the switching.*
8. Connect the Video Out to Mon to the Video input of a remote zone TV or monitor.
9. Connect a DB25 cable from the CR12 Controller Input A Connector to the To Multi-Room Controller connector on a McIntosh Control Center.  
*NOTE: The DB25 cable passes only the CD2, Tuner, Tape 1 and Aux audio along with matching Data, Sys Off and Power Control signals from the control center to the CR12.*

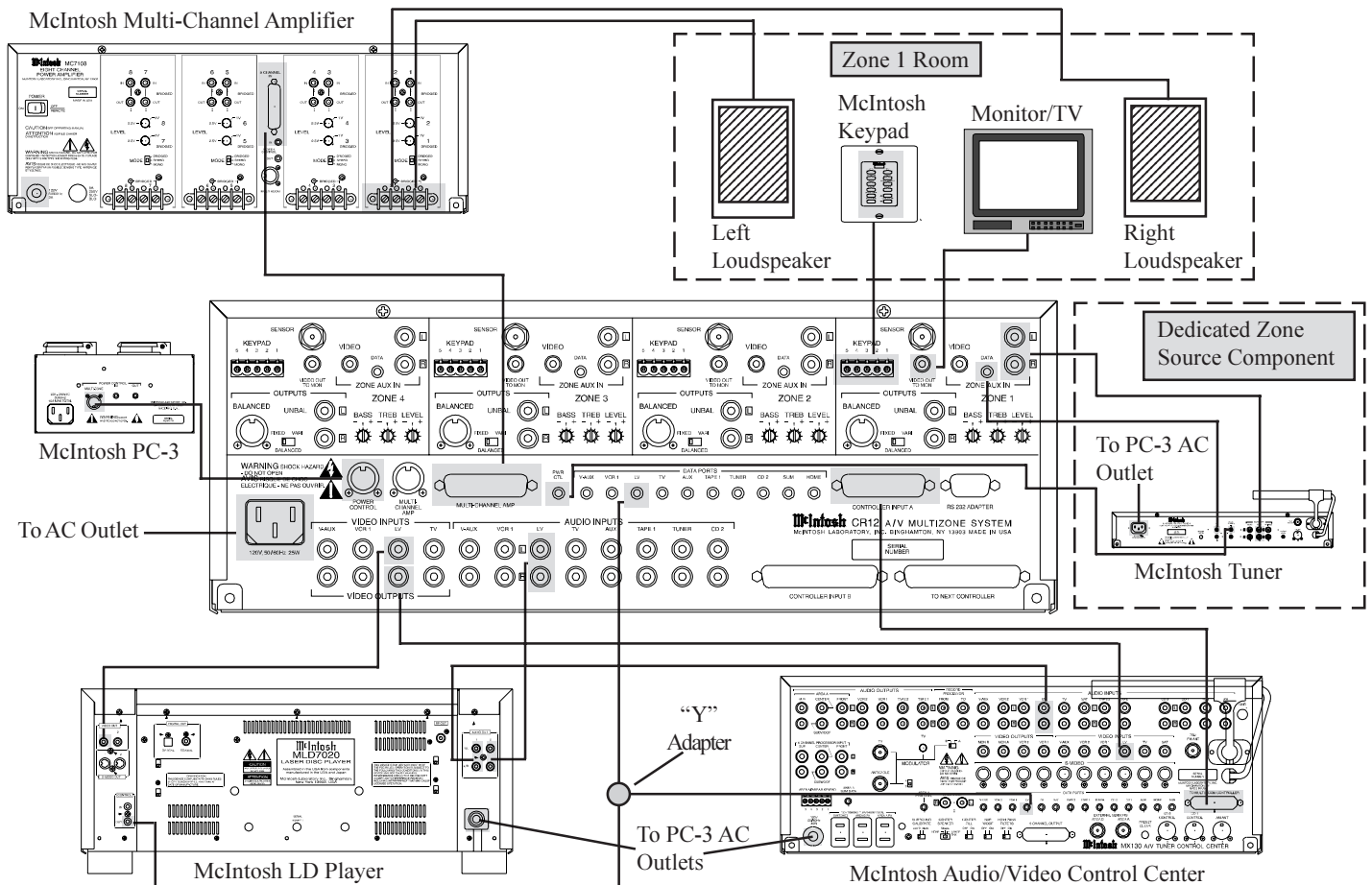



## How to Connect Additional CR12's

As many as six CR12's can be cascaded to supply audio and video to a maximum of 24 zones. Cascaded CR12's can also be connected with a McIntosh Control Center, which adds two additional zones.

1. Connect a DB37 shielded 37 conductor cable from the To Next Controller socket of the first CR12, to the Controller Input B of the second CR12. All Audio signals and the audio portion of A/V sources connected to the first CR12 will be sent down the cable to each succeeding CR12 to allow all remote zones to receive audio from all the Audio/Video sources.

2. Connect video cables from the video outputs of the first CR12 to the video inputs of the second CR12.
3. Repeat the video connections in and out of each CR12.
4. When cascaded CR12 systems are used with a McIntosh Control Center, connect the video outputs of the last CR12 to the matching video inputs of the control center

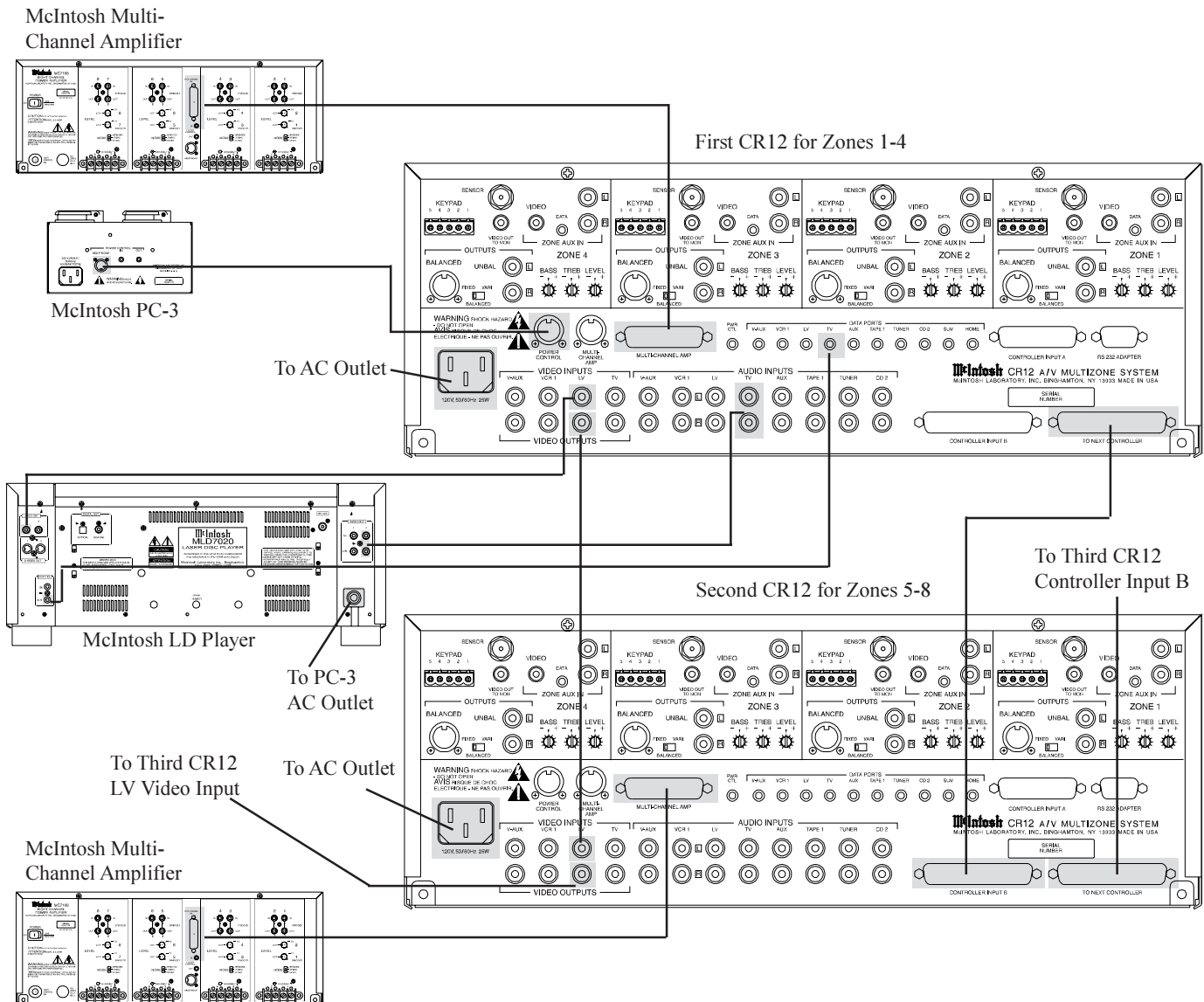



## How to Connect the CR12 in a Stand Alone System

### How to Connect the CR12 in a Stand Alone System

1. Connect the CR12 power cord to a live AC outlet.
2. Connect a McIntosh Power Controller to the CR12 using either the Din or Pwr Ctl (power control) connector and connect zone amplifier power cords to the appropriate outlets on the Power Controller.
3. Connect a McIntosh multi channel amplifier with a DB25 computer type cable from the CR12 Multi-Channel Amp connector to amplifier input connector.

*Note: Both audio and zone power control pass through this cable. Discrete zone audio cables may also be used, either balanced or unbalanced. Refer to Page 5 for the Din plug balanced terminal connections. Also connect a cable from the CR12 Din Multi-Channel Amp connector to the matching connector on the amplifier to provide zone power control.*

4. Connect a WK-3/WK-4 keypad, using 4 conductor shielded cable to a zone keypad terminal connector or connect a WK-2 keypad or R649 wall sensor to a zone

sensor connector with RG6 or RG59U coax cable.

5. Connect the video outputs of A/V source components to the CR12 video inputs and audio outputs to CR12 audio inputs.
6. For dedicated zone source components, connect their Audio, Video and Data outputs to the CR12 Zone Aux In connectors.

*Note: The A/V source signals used in a dedicated zone replace the front panel Aux signal source selection and are automatically switched when a plug is inserted into the Data port. If no data cable is used, insert 1/8 inch mini Stereo phone plug, (with a lead connected from the tip to the ring), into the Data port to activate the switching.*

7. Connect the outputs of audio source components to the CR12 audio inputs.
8. Connect the Video Out to Mon to the Video input of a remote zone TV or monitor.

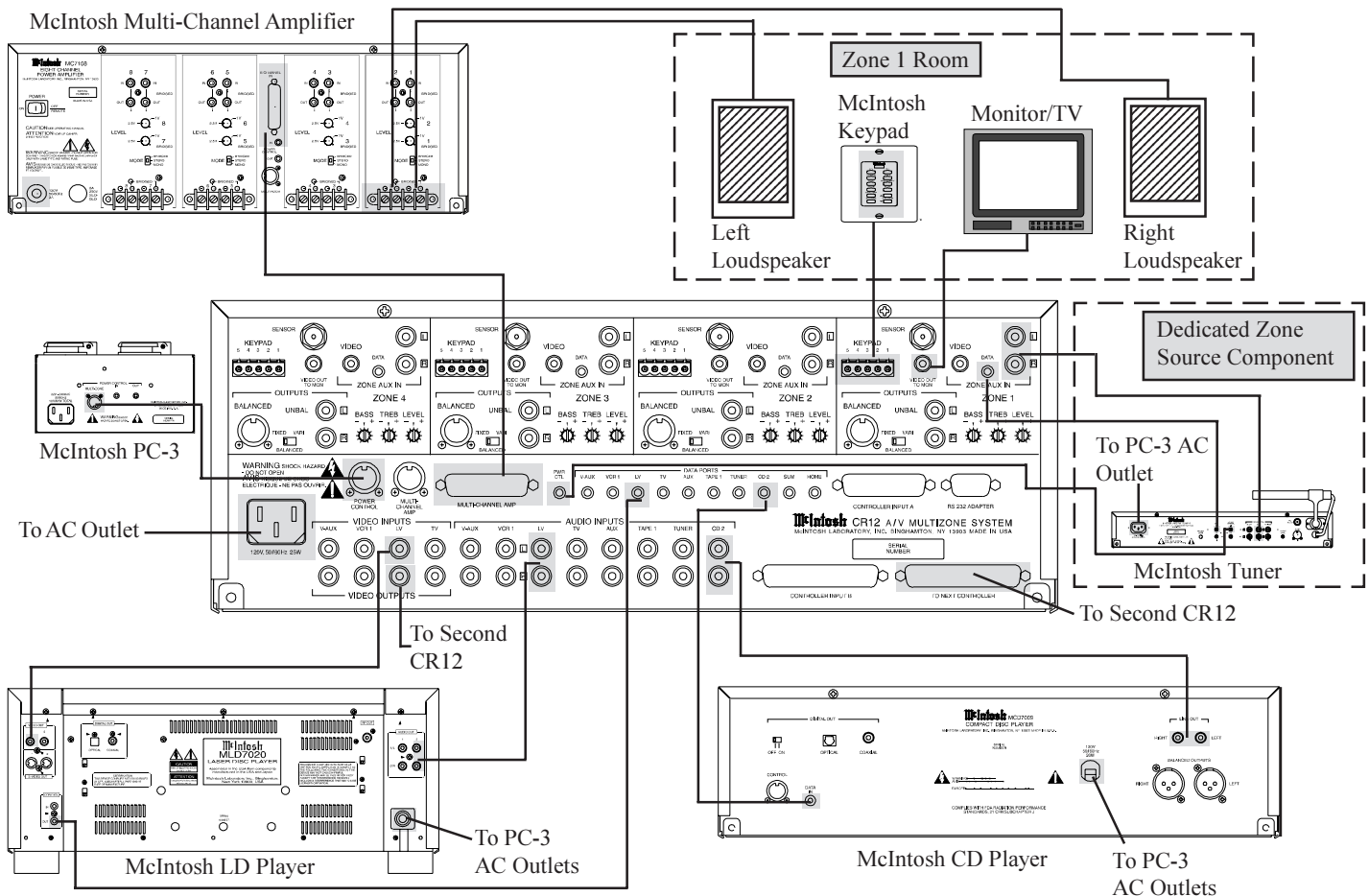

# CR12 Front Panel Displays, Push-Buttons and Switch

## CR12 Front Panel Displays, Push-Buttons and Switch

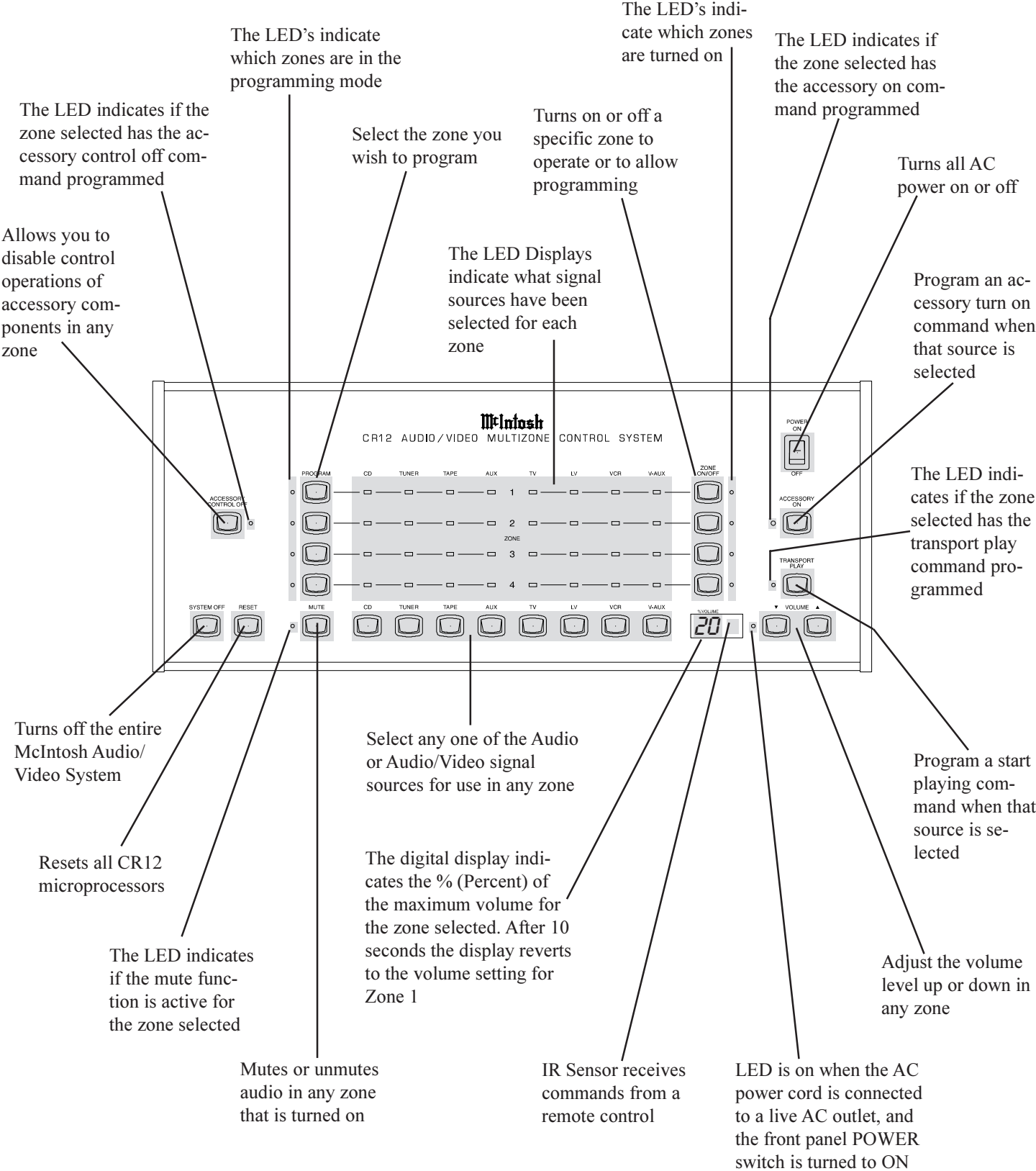



## How to Operate from the Front and Rear Panel

### Power On

Press the front panel Power switch to turn on the CR12. The power switch is normally left in the on position with the power cord in a live AC outlet. The red LED power indicator will stay on to indicate the CR12 is ready for use. Refer to figure 1.

*Note: Turn the power switch off only when the system is not going to be used for an extended time.*

### Zone On/Off

Turn on and operate any of the four zones by pressing a Zone On/Off push-button. The zone will turn on with the default or programmed signal source and volume level. Press the Zone On/Off push-button a second time to turn the zone off.

*Note: If zones 2, 3 or 4 are turned on, all front panel operating functions return to zone 1 after 10 seconds. If no programming has been performed, all zones will turn on to the tuner source at a volume indication of 20.*

### Reset of Microprocessors

In the event that the controls of the CR12 stop functioning, there is a user reset function built in. Press the Reset push-button and this will reset the CR12 microprocessors.

### Dedicated zone source components

If a specific CR12 zone has a source component dedicated exclusively to that zone, it can be operated in that zone with a keypad or remote control. When a dedicated zone source component is connected, it replaces the source component that is connected to the CR12 Aux inputs. If the CR12 is connected with a Control Center which has a source component connected to its Aux inputs, that component will not be available in the zone with the dedicated source component.

### System Off

Normally remote zones are turned on and off individually in each respective zone by pressing the Power push-button on a keypad or remote control.

If you desire to turn off all zones of an entire CR12 system simultaneously, including a control center and accessory source components, you can press the Sys Off push-button on the front panel. You can also turn off the entire system in any remote zone by pressing the Sys Off push-button on a keypad or remote control.

*Note: Individual remote zones should normally be turned off with the Power push-button since there may be other zones in use that would automatically be turned off by the Sys Off push-button in a specific zone.*

### Bass, Treble and Level Controls

Adjust the bass and treble controls for the desired tone shaping in each zone.

Adjust the zone level controls to increase or decrease a maximum of 6dB from the center detent position. Volume changes with the level controls add or subtract from the turn on levels. Refer to figure 2.

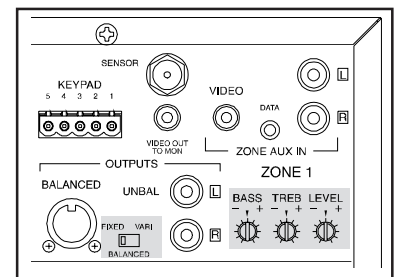

Figure 2

### Balanced and UnBalanced Outputs

Place the slide switch to the correct position according to the output hook-up, balanced or unbalanced connections.

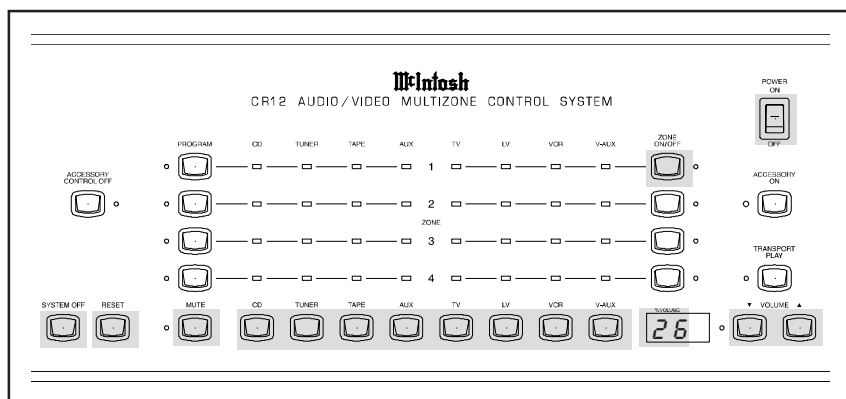

Figure 1

## How to Operate in Remote Zones

### Power

Press the Power push-button and the zone will turn on with either the default or programmed signal source and volume level. Press the Power push-button a second time to turn the zone off.

*Note: Operations in remote zones can be performed by pressing a push-button on a keypad or remote control. Refer to figures 3 and 4*

### Source Selection

Select and operate any available signal source by pressing the appropriate keypad or Remote Control push-button.

### Volume

The turn on volume level can be changed by pressing an up or down volume push-button.

### System Off

Normally remote zones are turned on and off individually in each respective zone by pressing the Power push-button on a keypad or remote control. If you desire to turn off all zones of an entire CR12 system simultaneously, including a control center and accessory components, you can press the Sys Off push-button. You can also turn off the entire system in any remote zone by pressing the Sys Off push-button on a keypad or remote control.

*Note: Individual remote zones should normally be turned off with the Power push-button since there may be other zones in use that would automatically be turned off by the Sys Off push-button in a specific zone.*

### Dedicated zone source components

If a specific CR12 zone has a source component dedicated exclusively to that zone, it can be operated in that zone with a keypad or remote control. When a dedicated zone source component is connected, it replaces the source component that is connected to the CR12 Aux inputs. If the CR12 is connected with a Control Center which has a source component connected to its Aux inputs, that component will not be available in the zone with the dedicated source component.

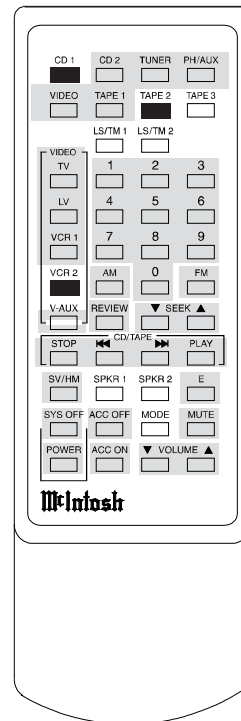

Figure 3

*Note: The shaded push-buttons operate with the CR12 as well as with a McIntosh Control Center connected to the CR12. The push-buttons shown in black only operate functions on McIntosh Control Centers. The white push-buttons are operational with other McIntosh models which also use the HR033 Remote Control.*

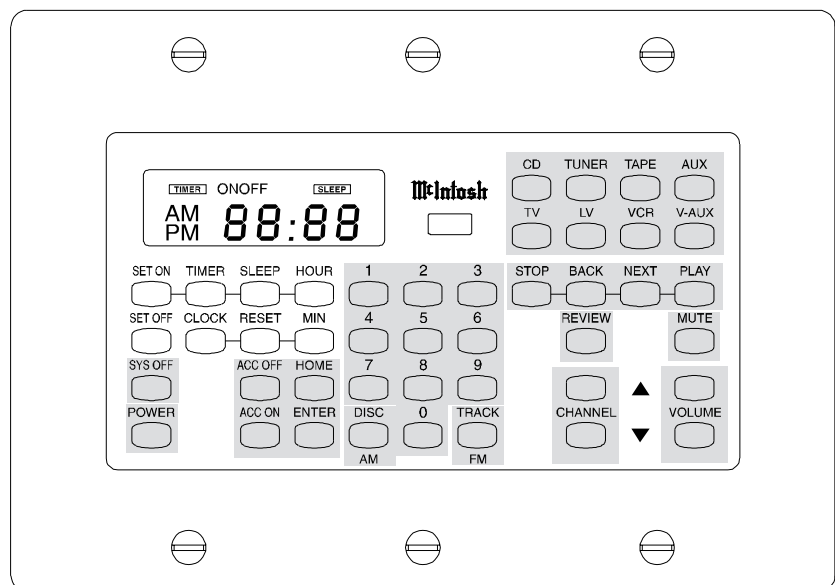

Figure 4





### Introduction to Programming

If no programming is performed, each zone will turn on with the default tuner signal source at an indicated volume level of 20. You can program a desired signal source and volume level for each separate zone which will appear every time that zone is turned on. It is also possible to change programming so the zone will turn on with the last selected signal source and volume level. You can also program a compatible source component such as a CD player to turn on and start playing when the zone is first turned on. It is also possible to program accessory source function control off for a zone which allows listening or viewing without being able to operate accessory source component functions. All programming is stored in permanent memory and is retained until changed, even in the event of a power failure. Refer to Figure 5.

### How to program a zone with the same signal source and volume level

1. Press a Program push-button for the zone you wish to turn on and program. The LED next to the selected zone will turn on.

*Note: After pressing a Program push-button, you must make any programming selections with 10 seconds of each other. If no further selection is made within 10 seconds, the zone programming will turn off and the CR12 front panel reverts to Zone 1 control. If the zone is already turned on when programming is initiated, the zone audio will mute and any video signals will blank as well.*

2. Select a signal source for the zone by pressing any of the eight signal source push-buttons. The selected signal source front panel LED will turn on for the zone being programmed. This will become the active signal source whenever that zone is turned on.
3. Press an Up or Down Volume push-button to select the desired volume level in the zone being programmed. The front panel display will indicate the selected level.
4. Press Program again or wait 10 seconds to exit the programming mode.

### How to program a zone with the last selected signal source and volume level

1. Press the Program push-button for the zone you wish to change.
2. Press the push-button for the signal source whose LED is currently illuminated. The entire row of front panel signal source LED's for that zone will turn off.
3. Press Program again or wait 10 seconds to exit the programming mode.
4. The next time the zone is turned on it will come on with the last selected signal source and volume level.

### How to program Accessory On

1. Press the Program push-button for the zone requiring Accessory on.
2. Press the push-button for the signal source requiring an accessory on command.
3. Press Accessory On to program a turn on signal. The LED next to the Accessory On push-button will turn On to indicate accessory on command has been selected.
4. Press Program again or wait 10 seconds to exit the programming mode.

*Note: The accessory source component must have a Data cable interconnected with the CR12 in order to receive the turn on command and must also have a power switch that automatically cycles off when AC power is removed.*

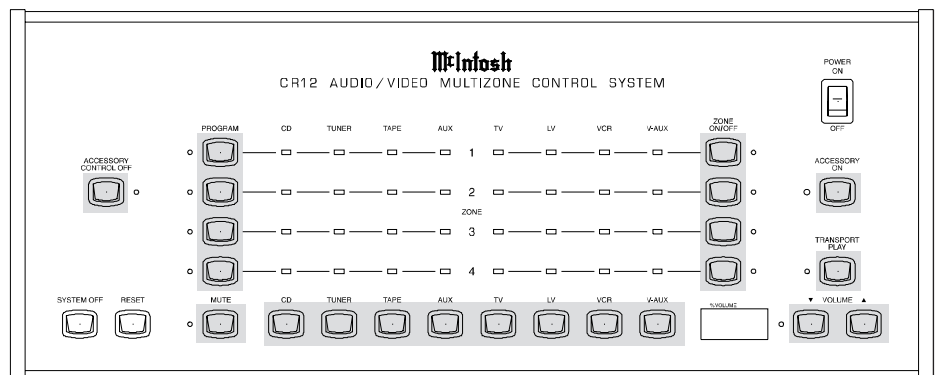

Figure 5



### How to program Transport Play

If the selected signal source is a component with a Play function, such as a CD player, Video Disc player or tape recorder, you can program to have the player start in Play mode after its power turns on.

1. Press the Program push-button for the zone requiring a Transport Play command.
2. Press the push-button for the signal source requiring the transport play command.
3. Press the Transport Play push-button. The LED next to the Transport Play push-button will turn on to indicate the transport play command has been selected.

*Note:* Programming Accessory source on in combination with Transport Play adds a 2 second time delay after a zone is turned on.

4. Press Program again or wait 10 seconds to exit the programming mode.

### How to program accessory control off

1. Press the program push-button for the zone requiring Accessory source Control Off.
2. Press the push-button for the signal source requiring Accessory source Control Off.
3. Press the Accessory Control Off push-button. The Red LED to the right of the Accessory Control Off push-button will turn ON to indicate that the Control function is OFF.

*Note:* Any source components connected for use in a dedicated zone will not be affected by the Accessory source Control Off function.

4. To exit the programming mode, press a Program push-button again or wait 10 seconds.

### Remote Zone Programming with a keypad or remote control

To change the previously programmed wakeup or turn on signal source and volume level, using a keypad or remote control.

1. Press a push-button for the desired new signal source.
2. Adjust the volume to the desired level.
3. Press and hold the new signal source push-button for 3 seconds.
4. The zone audio will mute, indicating that the change has occurred. Release the push-button to unmute.
5. The next time that zone is turned on, the new signal source and volume level will be in effect.



HR033 Push-Buttons

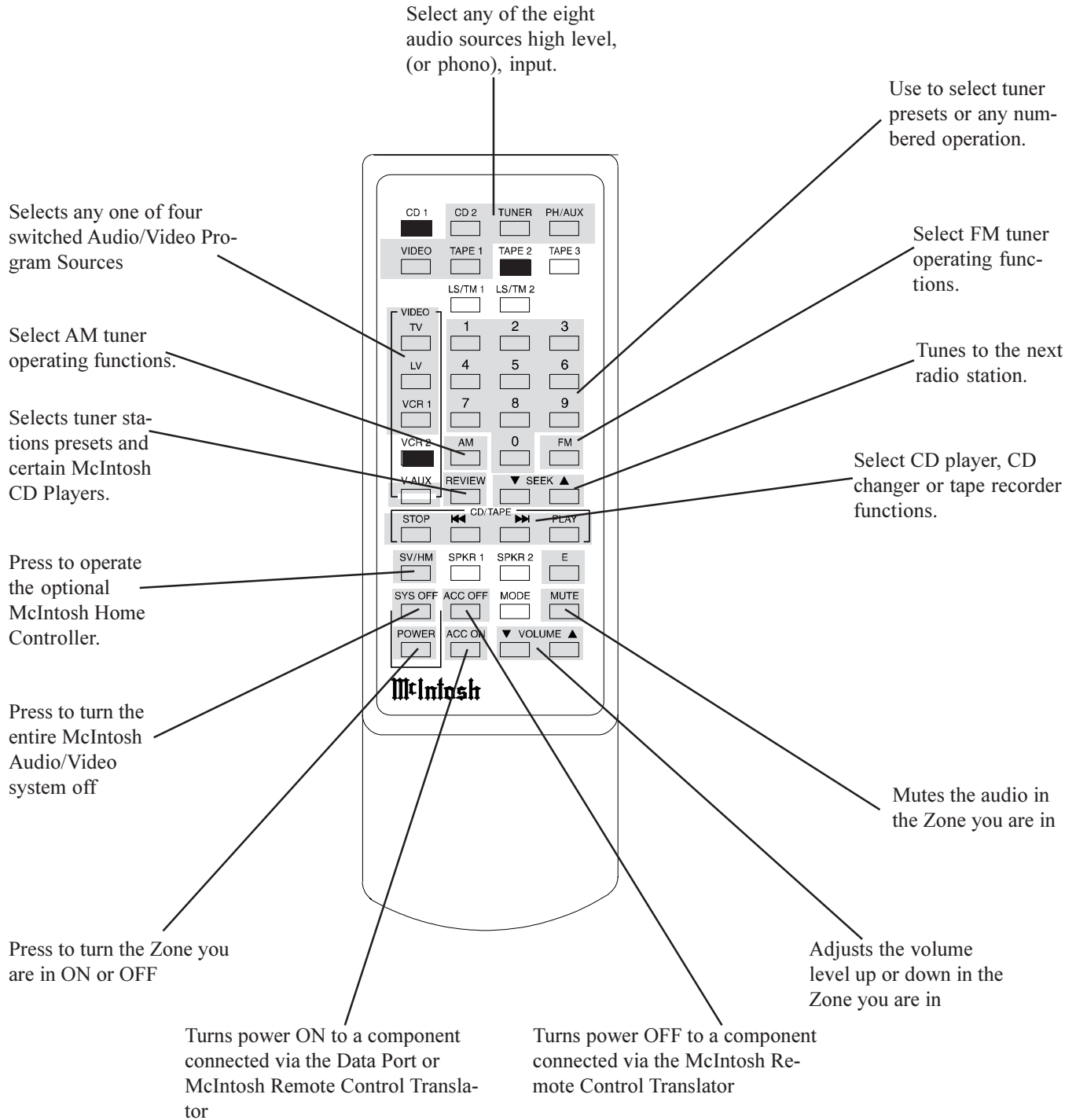

*Note: The shaded push-buttons operate with the CR12 as well as with a McIntosh Control Center connected to the CR12. The push-buttons shown in black only operate functions on McIntosh Control Centers. The white push-buttons are operational with other McIntosh models which also use the HR033 Remote Control.*

## How to Operate HR033

### Video

Press any of the four video signal source push-buttons to turn the zone on and select the video signal source for use.

### CD/Tape

When a CD Player or Tape Recorder is selected, the following operations are possible. Stop, Back Track, Next Track, and Play.

### Home

Press the Home push-button, and within 5 seconds, the appropriate number push-buttons (0 through 9) to operate the optional HC-1 Home Controller which in turn will control power to accessories.

### Sys Off

Press Sys Off (System Off), to turn off the entire McIntosh Audio/Video system. (This function is not possible in a zone that has been programmed for a priority Accessory Control lockout.)

### Power

Press Power to turn on the zone where the Remote Control is located.

### Acc On / Acc Off

Press the Acc On push-button to turn power on of an source component connected to the CR12 System and programmed. If a McIntosh Remote Control Translator is connected, press the Acc Off. to turn power Off of an accessory component connected to the CR12 System.

### CD2, Tuner, PH/Aux and Tape 1

Press any of these push-buttons to select the desired audio signal source.

### 0 through 9 Push-buttons

Press one or more numbered push-buttons for any function requiring direct number key access. This could be operating the HC-1 Home Controller, accessing tuner station presets, accessing tracks on a McIntosh MCD7009 CD Player, MLD7020 Laser Video Disc Player, or any similar function requiring direct key access. These push-buttons also can be used to operate accessory components interconnected with a McIntosh Remote Control Translator.

### Tuner Push-buttons

Use with a McIntosh tuner. Select AM or FM broadcast band. Press and release SEEK Up or Down to move from station to station. Press and hold a SEEK push-button to move continuously from station to station. Press REVIEW to start the automatic brief audition of each of the presets stored in the tuner memory. Press REVIEW a second time to stop on a station preset and exit the Review process.

### E (Enter)

Press E (Enter) to activate a programming process required by an accessory component connected to the CR12 with a McIntosh Remote Control Translator.

### Mute

Press Mute to silence or mute audio in any zone where the Remote Control is being used. Press Mute again, adjust the main volume or switch to a different signal source to unmute.

### Volume Up or Down

Press these push-buttons to raise or lower volume in any zone where the remote control is being used.

*Note: Remote Control Push-button Additional Functions when a McIntosh MCD7009 or MLD720 is being used:*

<u>CR12 Push-Button</u>	<u>MCD7009 Function</u>	<u>MLD7020 Function</u>
Review	+10	+10
Seek Down	REVerse	REVerse
Seek Up	FF (Fast Forward)	FF (Fast Forward)
E (Enter)	Pause	Pause
AM		Side A
FM		Side B
ACC On		Power



## Specifications

### Frequency Response

+0, -0.5dB from 20Hz to 20,000Hz

### Total Harmonic Distortion

0.01% From 20Hz to 20,000Hz

### Signal To Noise Ratio

90dB below rated output, (A Weighted)

### Sensitivity

250mV for 1.5V rated output

### Input Impedance

22K ohms

### Output Impedance

600 ohms, Balanced and Unbalanced

### Maximum Input Signal

8Volts

### Maximum Voltage Output

6Volts

### Voltage Gain

Input to Variable Outputs, 14dB

Input to Fixed (Balanced) Outputs, 0dB

### Tone Controls

+12dB, -12dB from center detent position

### Power Requirements

100 Volts, 50/60Hz at 25 watts.

110 Volts, 50/60Hz at 25 watts.

120 Volts, 50/60Hz at 25 watts.

220 Volts, 50/60Hz at 25 watts.

230 Volts, 50/60Hz at 25 watts.

240 Volts, 50/60Hz at 25 watts.

*NOTE: Refer to the rear panel of the CR12 for the correct voltage*

### Dimensions

17-1/2 inches (44.5cm) W, 7-1/16 inches (17.9cm) H, 20 inches (50.8cm) D, (including clearance for connectors)

## Packing Instructions

In the event it is necessary to repack the equipment for shipment, the equipment must be packed exactly as shown below. It is very important that the four plastic feet are attached to the bottom of the equipment. This will ensure the proper equipment location on the bottom pad. Failure to do this will result in shipping damage.

Use the original shipping carton and interior parts only if they are all in good serviceable condition. If a shipping carton or any of the interior part(s) are needed, please call or write Customer Service Department of McIntosh Laboratory. Please see the Part List for the correct part numbers.

Quantity	Part Number	Description
1	033762	Shipping carton only
2	033763	End Cap
1	033620	Inside carton only
1	033726	Top Pad
1	033729	Bottom pad
4	018578	Plastic foot
4	100159	#10-32 x 3/4" screw
4	104080	#10 Flat washer
1	047920	Shipping carton complete with all the above parts

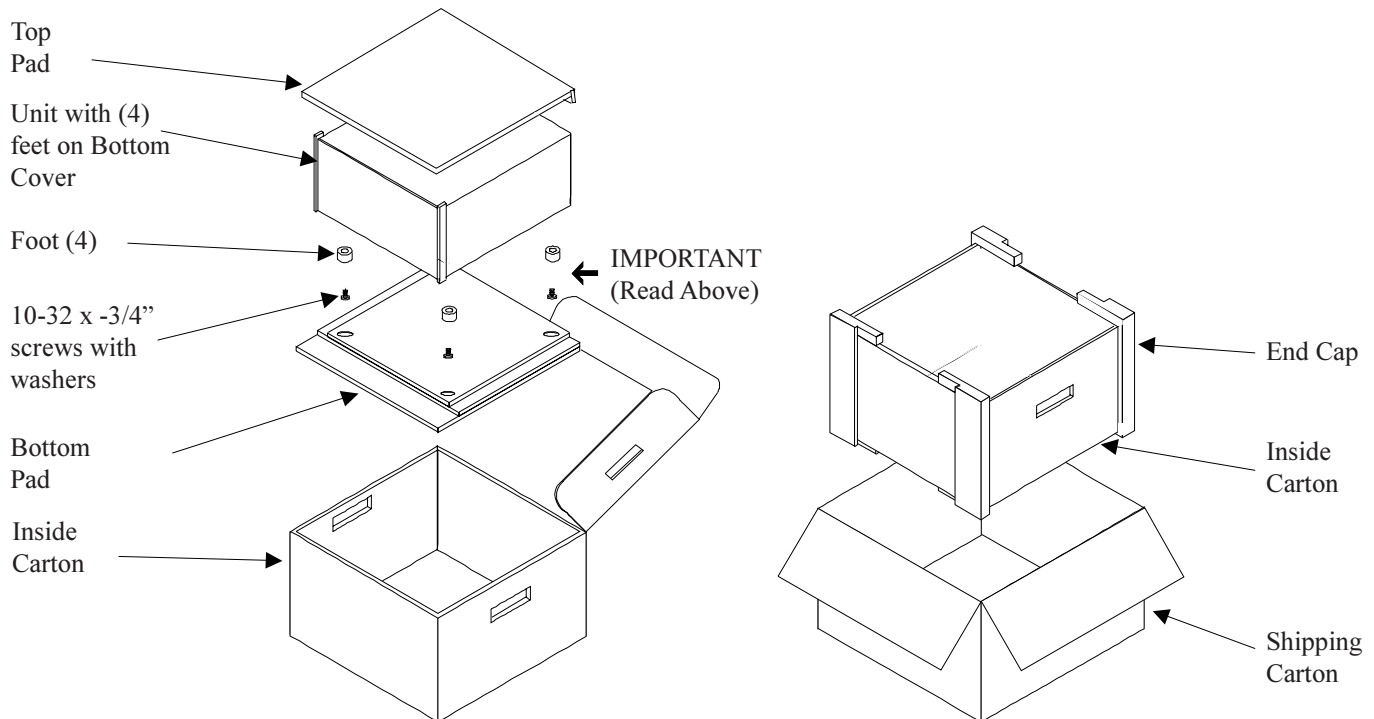

**McIntosh<sup>®</sup>**

McIntosh Laboratory, Inc.  
2 Chambers Street  
Binghamton, NY 13903